

KINTEK®

DOUBLE CONTACT TOOLHOLDERS DK
MANDRINI DOPPIO CONTATTO DK



www.kintek.it



**DOUBLE CONTACT
TOOLHOLDERS DK** 

MANDRINI
DOPPIO CONTATTO DK 

DOPPELKONTAKT
AUFNAHMEN DK 

CONOS DE
DOBLE CONTACTO 

PORTE-OUTILS
DOUBLE CONTACT DK 

ОПРАВКИ
DK 

DK 双接触面刀柄 



THE NUMEROUS ADVANTAGES OF DOUBLE CONTACT TOOLHOLDER DK:

- Enhanced rigidity thanks to simultaneous fit of taper and flange
- Improvement of the life of the cutting tool
- Improved stability leads to minimized vibration
- Greater bending stiffness allows for higher cutting data, hence higher productivity.



I NUMEROSI VANTAGGI DEL MANDRINO DOPPIO CONTATTO DK

- Maggiore rigidità grazie all'azione simultanea del contatto conico e di quello a flangia
- Miglioramento della vita dell'utensile di taglio
- Maggiore stabilità grazie alla riduzione delle vibrazioni
- Maggiore resistenza alla flessione per aumentare i dati di taglio e, quindi, la produttività.



DIE ZAHLREICHEN VORTEILE DES DK:

- Verbesserte Steifigkeit durch die Simultanwirkung des Kontakts des Kegels und des Flansches
- Verbesserung der Lebensdauer des Schneidwerkzeugs
- Verbesserte Stabilität durch eine beachtliche Schwingungssenkung
- Größere Biegesteifigkeit, welche die Produktivität erhöht.



LAS NUMEROSAS VENTAJAS DE LOS CONOS DE DOBLE CONTACTO:

- Mayor rigidez gracias al contacto simultaneo del cono y la valona
- Mejora la vida de las herramientas de corte
- Mejora la estabilidad gracias a la reducción de las vibraciones
- Su gran rigidez permite mayores condiciones de corte y por tanto mayor productividad



LES NOMBREUX AVANTAGES DE DK:

- Amélioration de la rigidité grâce au contact au niveau du cône et au niveau de la collerette
- Amélioration de la durée de vie de l'outil de coupe
- Amélioration de la stabilité grâce à la réduction des vibrations
- Grande résistance à la flexion qui permet d'augmenter les conditions de coupe et la productivité.



МНОГОЧИСЛЕННЫЕ ДОСТОИНСТВА DK:

- Повышение твердости благодаря синхронному действию контактов
- Продление срока годности
- Повышение стабильности вследствие снижения вибрации
- Повышение прочности при изгибе для улучшения качества обработки.



DK 刀头的优点:

- 得益于刀柄和法兰的同时配合产品的刚性大大提高
- 切削工具的寿命得以延长
- 更少的震动从而稳定性得以提高
- 更大的抗弯刚度从而提高了生产能力

GREAT ACCURACY - HIGH PRECISION LINE

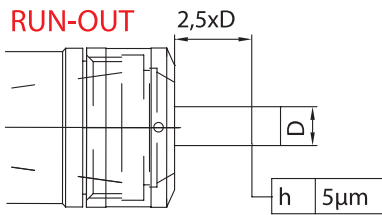

• **RUN OUT 5 MICRON at 2,5 times the diameter achieved only by using HP ER collets.**

The High level of accuracy is achieved either on the NOMINAL DIAMETER or by clamping the tool whose diameter is maximum 0,5 mm smaller than the nominal diameter.

- 20% higher clamping force (compared to standard ER collet chuck system).



• **RUN OUT 5 MICRON a 2,5 il diametro garantito esclusivamente tramite pinze ER PRECISE.**

L'elevata precisione si ottiene o sul DIAMETRO NOMINALE o chiudendo l'utensile con diametro al massimo di 0,5mm inferiore al diametro nominale.

- Forza di serraggio maggiore del 20% (rispetto a portapinza ER standard).



• **5 MICRON RUNDLAUFGENAUIGKEIT bei 2,5 Mal des Durchmessers nur durch Verwendung von HP-ER Spannzangen erreicht.**

Das Erreichen der hohen Genauigkeit erfolgt entweder am NENNDURCHMESSER oder durch das Spannen des Werkzeuges, wessen Durchmesser maximal 0,5 mm kleiner als der Nenndurchmesser ist.

- 20% höhere Spannkraft (im Vergleich zum Standard ER Spannzagenfuttersystem)



• **CONCENTRICIDAD DE 5 MICRAS en una longitud de voladizo de la herramienta de hasta 2,5 veces el diámetro de la misma.**

La alta precisión se obtiene tanto en el DIAMETRO NOMINAL como en la sujeción de la herramienta. Máximo rango de apriete 0.5mm por debajo del diámetro nominal.

- 20% mayor fuerza de apriete en comparación con un portapinzas ER estándar.



• **COAXIALITE 5 MICRON à 2,5 fois le diamètre obtenu uniquement en utilisant des pinces ER PRECISE.**

Le haut niveau de précision est obtenu soit sur le NOMINAL DIAMETER soit en serrant l'outil dont le diamètre est au maximum 0,5 mm inférieur au diamètre nominal.

- Force de serrage 20% supérieur si comparée au system de porte-pince standard



• **RUN OUT с 5 до 2,5 MICRON достигается только при использовании цанг PRECISION ER .**

Высокий уровень точности достигается либо при зажиме НОМИНАЛЬНОГО ДИАМЕТРА, либо путем зажима инструмента, диаметр которого не должен превышать 0,5мм номинального диаметра.

- Сила зажима на 20% выше по сравнению со стандартными цанговыми патронами



- 使用HP的弹簧筒夹，在2.5倍径的地方刀柄跳动达到5µ。所夹持的刀具需满足标称直径或比标称直径小0.5mm以内才能达到这个精度。

DOUBLE CONTACT ER COLLET CHUCK

DOPPELKONTAKT AUFNAHMEN ER SPANNZANGENFUTTER
 CONOS PORTAPINZAS DE DOBLE CONTACTO DE TIPO ER
 ЦАНГОВЫЙ ПАТРОН ER С ДВОЙНЫМ КОНТАКТОМ

MANDRINI PORTAPINZA A DOPPIO CONTATTO TIPO ER
 MADRINS DOUBLE CONTACT PORTE-PINCE ER
 ER双向夹头

MAS BT AD+B DOPPIO CONTATTO - DIN 6499

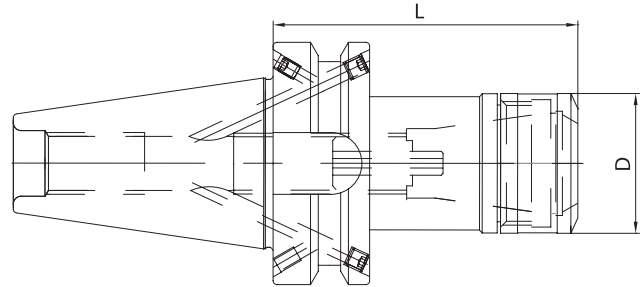

DOUBLE CONTACT

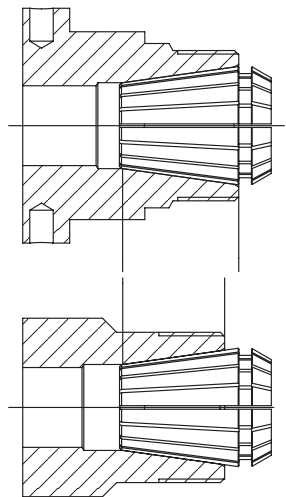

HIGH
PRECISION
LINE

STANDARD

	CODE N.	DESCRIPTION	ISO	L	D	ER	G2,5 30000
ISO 30	214-37231*	BT30H70ER16-HPDK	30	70	30	16	•
	214-37232*	BT30H70ER25-HPDK	30	70	40	25	•
	214-37233*	BT30H70ER32-HPDK	30	70	50	32	•
ISO 40	214-37219	BT40H70ER16-HPDK	40	70	30	16	•
	214-37220	BT40H70ER25-HPDK	40	70	40	25	•
	214-37221	BT40H70ER32-HPDK	40	70	50	32	•
ISO 40	214-37222	BT40H100ER16-HPDK	40	100	30	16	•
	214-37223	BT40H100ER25-HPDK	40	100	40	25	•
	214-37224	BT40H100ER32-HPDK	40	100	50	32	•

* Predisposti per pinze ER/ERHP/ERC
 * Suitable for ER/ERHP/ERC collets

- * BT30 only AD version
- * BT30 solo versione AD
- * BT30 nur AD Ausführung
- * BT30 solo versión AD
- * BT30 seulement Version AD
- * BT30 только с AD исполнением
- * BT30 只在AD版本下

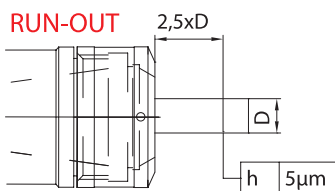

Accessories
 Accessori
 Zubehör
 Accesorios
 Accessoires
 Принадлежности
 零件



CODE N.	D	L	ER
812-203085	30	19,5	16
812-203086	40	22	25
812-203087	50	25	32

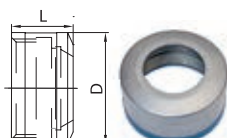

CODE N.	D	D1	ER
816-203069	30	3	16
816-203070	40	4	25
816-203071	50	4	32



DOUBLE CONTACT ER COLLET CHUCK

DOPPELKONTAKT AUFNAHMEN ER SPANNZANGENFUTTER
 CONOS PORTAPINZAS TIPO ER DE DOBLE CONTACTO
 ЦАНГОВЫЙ ПАТРОН ER С ДВОЙНЫМ КОНТАКТОМ

MANDRINI PORTAPINZA A DOPPIO CONTATTO TIPO ER
 MADRINS DOUBLE CONTACT PORTE-PINCE ER
 ER双向夹头

DIN69871 AD+B DOPPIO CONTATTO - DIN 6499

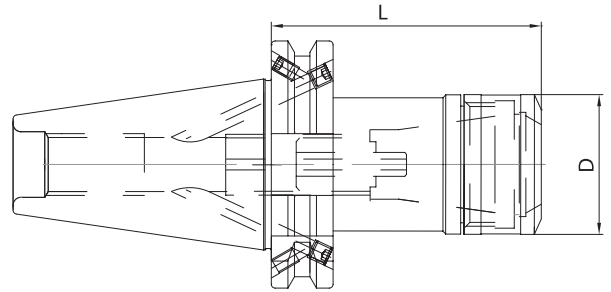

DOUBLE CONTACT

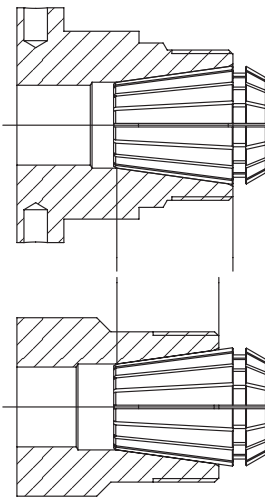

HIGH
PRECISION
LINE

STANDARD

	CODE N.	DESCRIPTION	ISO	L	D	ER	G2,5 30000
ISO40	214-37115	TC40H70ER16-HPDK	40	70	30	16	•
	214-37116	TC40H70ER25-HPDK	40	70	40	25	•
	214-37117	TC40H70ER32-HPDK	40	70	50	32	•
ISO 40	214-37118	TC40H100ER16-HPDK	40	100	30	16	•
	214-37119	TC40H100ER25-HPDK	40	100	40	25	•
	214-37120	TC40H100ER32-HPDK	40	100	50	32	•

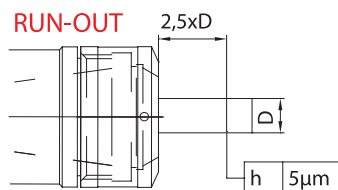

Accessories
 Accessori
 Zubehör
 Accessoires
 Принадлежности
 零件



COLLETS ER TYPE

ER TYP SPANNZANGEN PINZE TIPO ER
 PINZAS TIPO ER PINCES TYPE ER
 НАБОРЫ ЦАНГ ER ER 类型的夹头

CODE N.	D	L	ER
812-203085	30	19,5	16
812-203086	40	22	25
812-203087	50	25	32

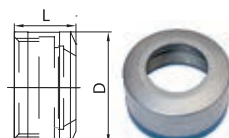

WRENCHES FOR NUT

SPANNSCHLÜSSEL FÜR SPANNMUTTER CHIAVI PER GHIERA
 LLAVES PARA TUERCA CLES DE SERRAGE POUR ECROU
 КЛЮЧИ ДЛЯ СТАНДАРТНЫХ ГАЕК 标准螺母用扳手

CODE N.	D	D1	ER
816-203069	30	3	16
816-203070	40	4	25
816-203071	50	4	32



DOUBLE CONTACT ER COLLET CHUCK



DOPPELKONTAKT AUFNAHMEN ER SPANNZANGENFUTTER
CONOS PORTAPINZAS TIPO ER DE DOBLE CONTACTO
ЦАНГОВЫЙ ПАТРОН ER С ДВОЙНЫМ КОНТАКТОМ

MANDRINI PORTAPINZA A DOPPIO CONTATTO TIPO ER
MADRINS DOUBLE CONTACT PORTE-PINCE ER
ER双向夹头

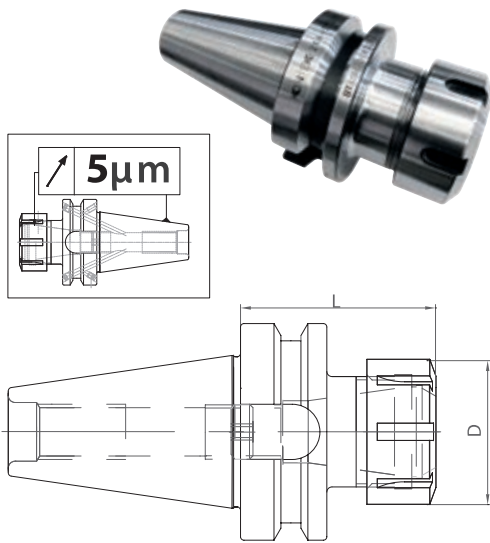
MAS 403/BT AD

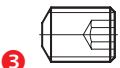
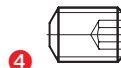

CODE N.	DESCRIPTION	ISO	ER	D	L	G2,5 30000 RPM
214-37201	BT30H70ER16 AD	30	16	32	70	•
214-37202	BT30H70ER20 AD	30	20	35	70	•
214-37203	BT30H70ER25 AD	30	25	42	70	•
214-37204	BT30H70ER32 AD	30	32	50	70	•
214-37205	BT40H70ER16 AD	40	16	32	70	•
214-37206	BT40H70ER25 AD	40	25	42	70	•
214-37207	BT40H70ER32 AD	40	32	50	70	•
214-37208	BT40H70ER40 AD	40	40	63	70	•
214-37209	BT40H100ER16 AD	40	16	32	100	•
214-37210	BT40H100ER25 AD	40	25	42	100	•
214-37211	BT40H100ER32 AD	40	32	50	100	•
214-37212	BT40H100ER40 AD	40	40	63	100	•
214-37213	BT50H80ER32 AD	50	32	50	80	•
214-37215	BT50H100ER32 AD	50	32	50	100	•
214-37216	BT50H100ER40 AD	50	40	63	100	•
214-37217	BT50H160ER32 AD	50	32	50	160	•
214-37218	BT50H200ER32 AD	50	32	50	200	•

TAPE	SCREW	QUANTITY	SCREW	QUANTITY	ER	NUT	STOP SCREW
							
ISO 40	811-102002 M4X5	2	811-102002 M4X5	2	16	812-203080	811-303119
ISO 50	811-102001 M4X4	2	811-102010 M5X6	2	20	812-203081	811-303120
					25	812-203082	811-303121
					32	812-203083	811-303118
					40	812-203084	811-303122

Spare parts • Componenti • Piezas de repuesto • Ersatzteile • Pièces détachées • Запасные части • 零件

DOUBLE CONTACT ER COLLET CHUCK

DOPPELKONTAKT AUFNAHMEN ER SPANNZANGENFUTTER
CONOS PORTAPINZAS TIPO ER DE DOBLE CONTACTO
ЦАНГОВЫЙ ПАТРОН ER С ДВОЙНЫМ КОНТАКТОМ

MANDRINI PORTAPINZA A DOPPIO CONTATTO TIPO ER
MADRINS DOUBLE CONTACT PORTE-PINCE ER
ER双向夹头

DIN 69871 AD

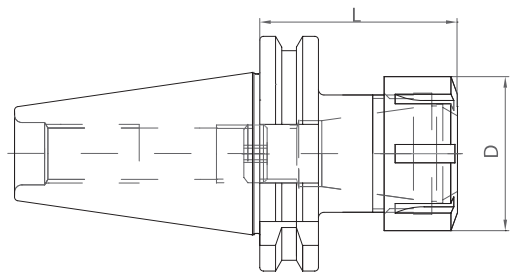
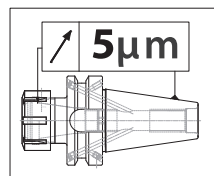

ER	NUT
	
16	812-203080
20	812-203081
25	812-203082
32	812-203083
40	812-203084

Code N.	DESCRIPTION	ISO	ER	D	L	G2,5 30000 RPM
214-37101	TC40H70ER16 AD	40	16	32	70	•
214-37102	TC40H70ER25 AD	40	25	42	70	•
214-37103	TC40H70ER32 AD	40	32	50	70	•
214-37104	TC40H70ER40 AD	40	40	63	70	•
214-37105	TC40H100ER16 AD	40	16	32	100	•
214-37106	TC40H100ER25 AD	40	25	42	100	•
214-37107	TC40H100ER32 AD	40	32	50	100	•
214-37108	TC40H100ER40 AD	40	40	63	100	•
214-37109	TC50H70ER32 AD	50	32	50	70	•
214-37110	TC50H80ER40 AD	50	40	63	80	•

DOUBLE CONTACT FACE MILL HOLDERS-TENONS DRIVE

DOPPELKONTAKT AUFNAHMEN AUFSTÄCKFRÄSDORNE
CONOS PORTAFRESAS DE DOBLE CONTACTO

MANDRINI PORTAFRESE A DOPPIO CONTATTO A TRASCINAMENTO FISSO
MADRINS DOUBLE CONTACT PORTE-FRAISE
双向铣刀柄

ОПРАВКИ ДЛЯ НАСАДНЫХ ФРЕЗ С ДВОЙНЫМ КОНТАКТОМ

MAS 403/BT AD



CODE N.	DESCRIPTION	ISO	D	L1	L2	D2	G2,5 25000 RPM
216-77207	BT30H35D16 AD	30	16	35	17	38	•
216-77201	BT30H45D22F AD	30	22	45	19	48	•
216-77202	BT30H45D27F AD	30	27	45	21	60	•
216-77208	BT40H45D16F AD	40	16	45	17	38	•
216-77203	BT40H45D22F AD	40	22	45	19	48	•
216-77204	BT40H60D22F AD	40	22	60	19	48	•
216-77205	BT40H45D27F AD	40	27	45	21	60	•
216-77206	BT40H60D27F AD	40	27	60	21	60	•
216-77211	BT50H60D22F AD	50	22	60	19	48	•
216-77212	BT50H60D27F AD	50	27	60	21	60	•

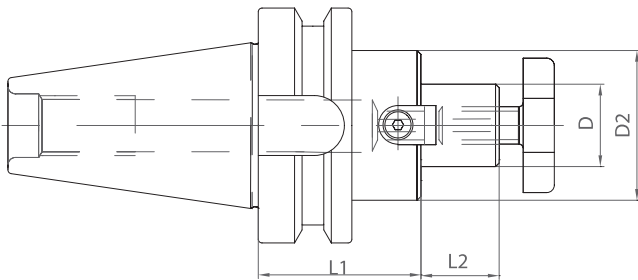

DOUBLE CONTACT FACE MILL HOLDERS-TENONS DRIVE

DOPPELKONTAKT AUFNAHMEN AUFSTÄCKFRÄSDORNE
CONOS PORTAFRESAS DE DOBLE CONTACTO

MANDRINI PORTAFRESE A DOPPIO CONTATTO A TRASCINAMENTO FISSO
MADRINS DOUBLE CONTACT PORTE-FRAISE
双向铣刀柄

ОПРАВКИ ДЛЯ НАСАДНЫХ ФРЕЗ С ДВОЙНЫМ КОНТАКТОМ

MAS 403/BT AD

CODE N.	DESCRIPTION	ISO	D	L1	L2	D2	G2,5 25000 RPM
216-77214	BT40H100D16F AD	40	16	100	17	38	•
216-77215	BT40H100D22F AD	40	22	100	19	48	•
216-77216	BT40H100D27F AD	40	27	100	21	55	•
216-77217	BT40H100D32F AD	40	32	100	24	58	•
216-77218	BT40H100D40F AD	40	40	100	27	70	•

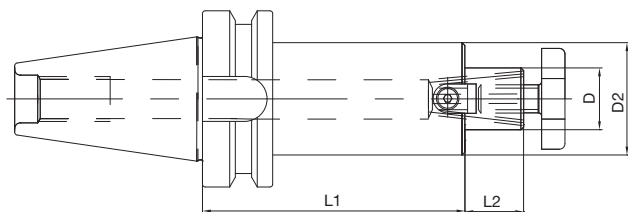

Spare parts • Componenti • Ersatzteile • Piezas de repuesto
Pièces détachées • Запасные части • 零件

D	CROSS SCREW	TENON	SCREW	WRENCH
16	811-107003	814-202280	811-101004	816-130002
22	811-107004	814-202250	811-101011	816-130003
27	811-107005	814-202270	811-101018	816-130004
32	811-107006	814-202170	811-101027	816-130005
40	811-107007	814-202180	811-101028	816-130006

DOUBLE CONTACT FACE MILL HOLDERS-TENONS DRIVE

DOPPELKONTAKT AUFNAHMEN AUFSTÄCKFRÄSDORNE
CONOS TIPO PORTAFRESAS DE DOBLE CONTACTO
ОПРАВКИ ДЛЯ НАСАДНЫХ ФРЕЗ С ДВОЙНЫМ КОНТАКТОМ

MANDRINI PORTAFRESE A DOPPIO CONTATTO A TRASCINAMENTO FISSO
MADRINS DOUBLE CONTACT PORTE-FRAISE
双向铣刀柄

DIN 69871 AD



CODE N.	DESCRIPTION	ISO	D	L1	L2	D2	G2,5 25000 RPM
216-77103	TC40H35D16F AD	40	16	35	17	38	•
216-77101	TC40H35D22F AD	40	22	35	19	48	•
216-77102	TC40H60D27F AD	40	27	60	21	58	•
216-77106	TC50H60D27F AD	50	27	60	21	58	•

Spare parts • Componenti • Ersatzteile • Piezas de repuesto
Pièces détachées • Запасные части • 零件

D	CROSS SCREW	TENON	SCREW	WRENCH
16	811-107003	814-202280	811-101004	816-130002
22	811-107004	814-202250	811-101011	816-130003
27	811-107005	814-202270	811-101018	816-130004
32	811-107006	814-202630	811-101029	816-130005
40	811-107007	814-202710	811-101029	816-130006

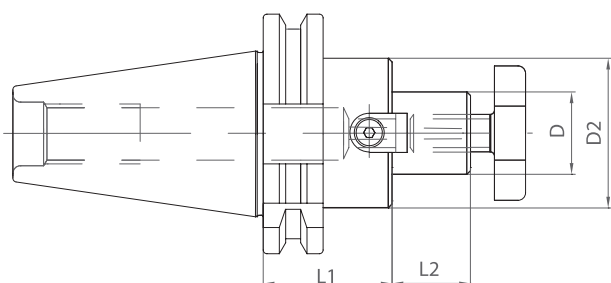

DOUBLE CONTACT FACE MILL HOLDERS-TENONS DRIVE

DOPPELKONTAKT AUFNAHMEN AUFSTÄCKFRÄSDORNE
CONOS TIPO PORTAFRESAS DE DOBLE CONTACTO
ОПРАВКИ ДЛЯ НАСАДНЫХ ФРЕЗ С ДВОЙНЫМ КОНТАКТОМ

MANDRINI PORTAFRESE A DOPPIO CONTATTO A TRASCINAMENTO FISSO
MADRINS DOUBLE CONTACT PORTE-FRAISE
双向铣刀柄

DIN69871 AD

CODE N.	DESCRIPTION	ISO	D	L1	L2	D2	D2	G2,5 25000 RPM
216-77107	TC40H100D16F AD	40	16	100	17	32	42	•
216-77108	TC40H100D22F AD	40	22	100	19	40	49	•
216-77109	TC40H100D27F AD	40	27	100	21	48	48	•

Spare parts • Componenti • Ersatzteile • Piezas de repuesto
Pièces détachées • Запасные части • 零件

D	CROSS SCREW	TENON	SCREW	WRENCH
16	811-107003	814-202140	811-101003	816-130002
22	811-107004	814-202150	811-101010	816-130003
27	811-107005	814-202160	811-101017	816-130004

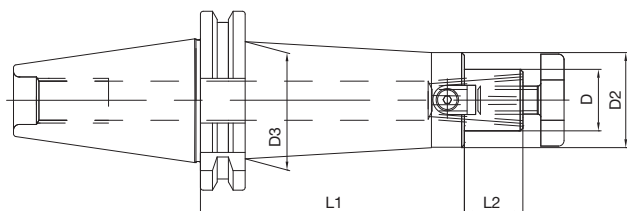

DOUBLE CONTACT END MILL HOLDERS WELDON

DOPPELKONTAKT AUFNAHMEN WELDON

MANDRINI PORTAFRESE A DOPPIO CONTATTO TIPO WELDON

CONOS TIPO WELDON DE DOBLE CONTACTO

MADRINS DOUBLE CONTACT WELDON

ОПРАВКИ С КРЕПЛЕНИЕМ WELDON С ДВОЙНЫМ КОНТАКТОМ

WELDON双向铣刀柄

MAS 403/BT AD

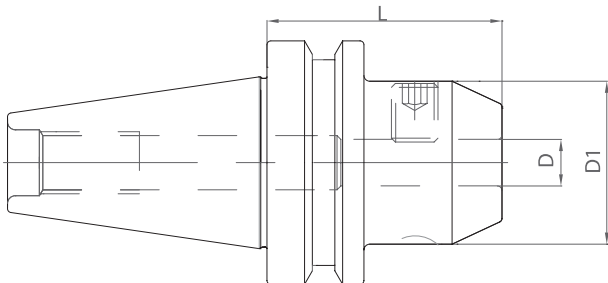

CODE N.	DESCRIPTION	ISO	D	L	D1	G6,3 15000 RPM
213-17225	BT30H60WE06 AD	30	6	60	25	•
213-17226	BT30H60WE08 AD	30	8	60	28	•
213-17227	BT30H60WE10 AD	30	10	60	35	•
213-17228	BT30H60WE12 AD	30	12	60	42	•
213-17229	BT30H75WE16 AD	30	16	75	48	•
213-17230	BT30H75WE20 AD	30	20	75	52	•
213-17231	BT30H90WE25 AD	30	25	90	65	•
213-17232	BT40H50WE06 AD	40	6	50	25	•
213-17233	BT40H50WE08 AD	40	8	50	28	•
213-17234	BT40H63WE10 AD	40	10	63	35	•
213-17235	BT40H63WE12 AD	40	12	63	42	•
213-17236	BT40H63WE16 AD	40	16	63	48	•
213-17238	BT40H63WE20 AD	40	20	63	52	•
213-17239	BT40H100WE25 AD	40	25	100	65	•
213-17240	BT40H100WE32 AD	40	32	100	72	•
213-17249	BT50H63WE06 AD	50	6	63	25	•
213-17250	BT50H63WE08 AD	50	8	63	28	•
213-17251	BT50H70WE10 AD	50	10	70	35	•
213-17252	BT50H80WE12 AD	50	12	80	42	•
213-17253	BT50H80WE16 AD	50	16	80	48	•
213-17255	BT50H80WE20 AD	50	20	80	52	•
213-17256	BT50H100WE25 AD	50	25	100	65	•
213-17257	BT50H105WE32 AD	50	32	105	72	•
213-17258	BT50H120WE40 AD	50	40	120	80	•

DOUBLE CONTACT END MILL HOLDERS WELDON

DOPPELKONTAKT AUFNAHMEN WELDON

MANDRINI PORTAFRESE A DOPPIO CONTATTO TIPO WELDON

CONOS TIPO WELDON DE DOBLE CONTACTO

MADRINS DOUBLE CONTACT WELDON

ОПРАВКИ С КРЕПЛЕНИЕМ WELDON С ДВОЙНЫМ КОНТАКТОМ

WELDON双向铣刀柄

DIN 69871 AD

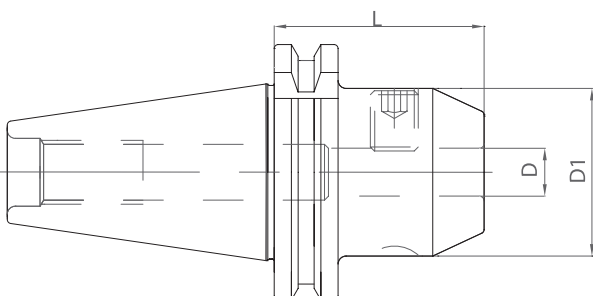

CODE N.	DESCRIPTION	ISO	D	L	D1	G6,3 15000 RPM
213-17113	TC40H50WE06 AD	40	6	50	25	•
213-17114	TC40H50WE08 AD	40	8	50	28	•
213-17115	TC40H63WE10 AD	40	10	50	35	•
213-17116	TC40H63WE12 AD	40	12	50	42	•
213-17117	TC40H63WE16 AD	40	16	63	48	•
213-17119	TC40H63WE20 AD	40	20	63	52	•
213-17120	TC40H100WE25 AD	40	25	100	65	•
213-17121	TC40H100WE32 AD	40	32	100	72	•
213-17126	TC50H63WE16 AD	50	16	63	48	•
213-17128	TC50H63WE20 AD	50	20	63	52	•
213-17129	TC50H80WE25 AD	50	25	80	65	•
213-17130	TC50H100WE32 AD	50	32	100	72	•
213-17131	TC50H120WE40 AD	50	40	120	80	•

MILLING CHUCK KITS

KRAFTSPANNFUTTERSATZ KIT FORTE SERRAGGIO
 SET DE GRAN APRIETE JEUX À FORT SERRAGE
 НАБОРЫ СИЛОВЫХ ПАТРОНОВ С ЦАНГАМИ К НИМ 铣夹头组套

Kit Box: 1 milling chuck + 1 collets kit + 1 wrench

Cassetta Corredo: 1 mandrino forte serraggio + 1 serie pinze + 1 chiave

Contenido del set: 1 Cono de gran apriete + 1 Juego de pinzas + 1 Llave

Ausstattungskasten: 1 Kraftspannfutter + 1 Spannzangensatz + 1 Spannschlüssel

Boîte d'équipement: 1 mandrin à fort serrage + 1 jeux de pince + 1 clé

Набор: 1 патрон + 1 набор цанг + 1 ключ

组件盒: 1 个铣夹头 + 1 个夹头套装 + 1 个扳手



	CODICE ORDINAZIONE ORDER CODE	COMPOSIZIONE COMPOSITION
ISO 40	KIT BT40 C20DK	N°1 BT40 L105 C20 + n°5 pinze K20: Ø6,8,10,12,16
	KIT BT40 C32DK	N°1 BT40 L105 C32 + n°7 pinze K32: Ø6,8,10,12,16,20,25
	KIT TC40 C20DK	N°1 TC 40 L105 C20 + n°5 pinze K20: Ø6,8,10,12,16
	KIT TC40 C32DK	N°1 TC 40 L105 C32 + n°7 pinze K32: Ø6,8,10,12,16,20,25
	KIT BT50 C20DK	N°1 BT50 L105 C20 + n°5 pinze K20: 6,8,10,12,16
	KIT BT50 C32DK	N°1 BT50 L105 C32 + n°7 pinze K32: 6,8,10,12,16,20,25

MILLING CHUCK

KRAFTSPANNFUTTER MANDRINI A FORTE SERRAGGIO
 CONOS PORTAHERRAMIENTAS DE GRAN APRIETE DE DOBLE CONTACTO MANDRINS A FORT SERRAGE
 УСИЛЕННЫЕ ОПРАВКИ 铣夹头

MAS 403/BT A



pag. 188

Accessories
 Accessori
 Zubehör
 Accesorios



pag. 188

Accessoires
 Принадлежности
 零件

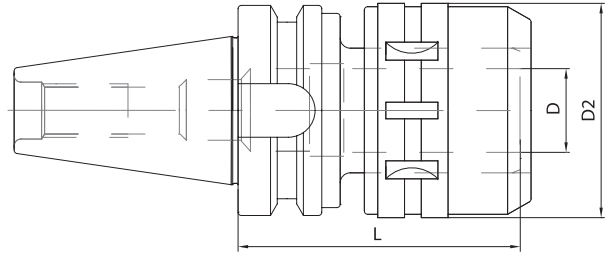

CODE N.	DESCRIPTION	ISO	D	D2	L	G6,3 12000 RPM
214-07201	BT40H105C20	40	20	54	105	●
214-07202	BT40H105C32	40	32	72	105	●

MILLING CHUCK

KRAFTSPANNFUTTER MANDRINI A FORTE SERRAGGIO
 CONOS PORTAHERRAMIENTAS DE GRAN APRIETE DE DOBLE CONTACTO MANDRINS A FORT SERRAGE
 УСИЛЕННЫЕ ОПРАВКИ 铣夹头

DIN 68971



pag. 188

Accessories
 Accessori
 Zubehör
 Accesorios



pag. 188

Accessoires
 Принадлежности
 零件

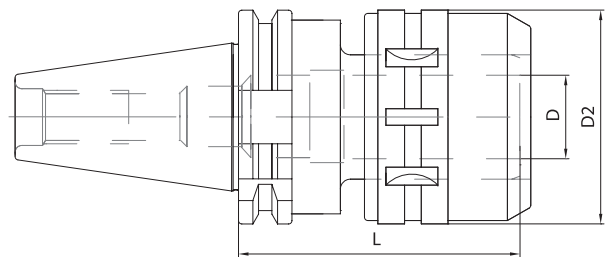

CODE N.	DESCRIPTION	ISO	D	D2	L	G6,3 12000 RPM
214-07101	TC40H105C20	40	20	54	105	●
214-07102	TC40H105C32	40	32	72	105	●

REDUCTION ISO 40/50 DIN69871-AD/B – POLYGONAL SHANK

REDUKTION SK 40/50 DIN69871 MIT POLYGONSCHAFT
 REDUCCION DE DOBLE CONTACTO ISO 40/50 DIN 69871-AD/B
 CON SALIDA A SUJECION POLIGONAL
 ПЕРЕХОДНИКИ С ISO 40/50 DIN69871-AD/B НА EPS

RIDUZIONE ISO 40/50 DIN 69871-AD/B PER ATTACCO POLIGONALE
 REDUCTION ISO 40/50 DIN69871 AVEC ATTACHEMENT POLYGAONALE
 DIN69871-AD/B 多边形缩减柄

DIN ISO 26623-1 - **DIN 69871**

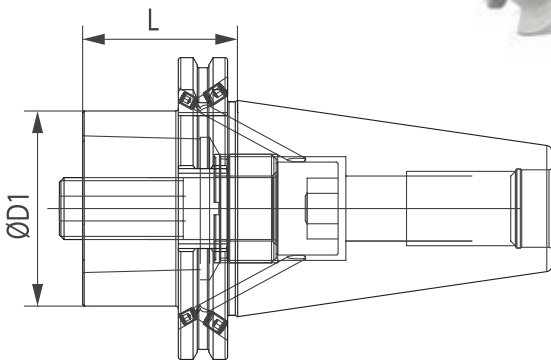

CODE N.	ATTACCO SHANK	D1 mm	L mm
TC40H50C50DK	40DIN69871 AD/B	50	50
TC40H85C63DK	40DIN69871 AD/B	63	85
TC50H60C40DK	50DIN69871 AD/B	40	60
TC50H30C50DK	50DIN69871 AD/B	50	30
TC50H70C50DK	50DIN69871 AD/B	50	70
TC50H50C63DK	50DIN69871 AD/B	63	50
TC50H100C63DK	50DIN69871 AD/B	63	100
TC50H120C80DK	50DIN69871 AD/B	80	120

03

REDUCTION BT40/50-AD/B – POLYGONAL SHANK

REDUKTION BT40/50-AD/B MIT POLYGONSCHAFT
 REDUCCION DE DOBLE CONTACTO BT 40/50-AD/B
 CON SALIDA A SUJECION POLIGONAL
 ПЕРЕХОДНИКИ С BT40/50-AD/B НА DIN

RIDUZIONE BT40/50-AD/B CON ATTACCO POLIGONALE
 REDUCTION BT40/50-AD/B AVEC ATTACHEMENT POLYGAONALE
 BT40/50-AD/B 多边形缩减柄

DIN ISO 26623-1 - **JIS-B 6339 MAS 403/BT**

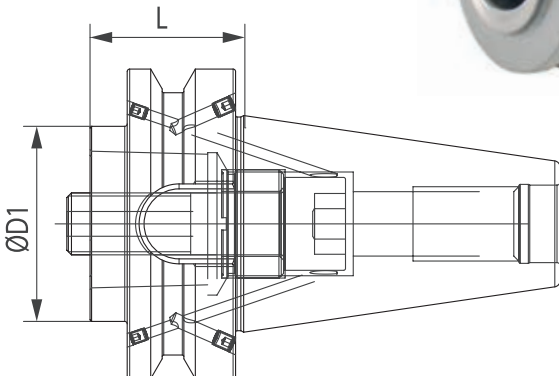

CODE N.	ATTACCO SHANK	D1 mm	L mm
BT40H40C40DK	40MAS403/BT AD/B	40	40
BT40H50C50DK	40MAS403/BT AD/B	50	50
BT40H75C63DK	40MAS403/BT AD/B	63	75
BT50H70C40DK	50MAS403/BT AD/B	40	70
BT50H40C50DK	50MAS403/BT AD/B	50	40
BT50H80C50DK	50MAS403/BT AD/B	50	80
BT50H50C63DK	50MAS403/BT AD/B	63	50
BT50H100C63DK	50MAS403/BT AD/B	63	100
BT50H70C80DK	50MAS403/BT AD/B	80	70
BT50H120C80DK	50MAS403/BT AD/B	80	120

KINTEK®

DOPPELKONTAKT VIERKANTWERKZEUGHALTER

DOPPELKONTAKT DREIFACH-VIERKANTWERKZEUGHALTER
PORTABARRAS PARA CUADRADILLO DE DOBLE CONTACTO
ОПРАВКА ДК С КВАДРАТОМ

PORTABARENO QUADRO DOPPIO CONTATTO
PORTE OUTIL CARRÉ À DOUBLE CONTACT
双触面方形刀柄

MAS 403/BT

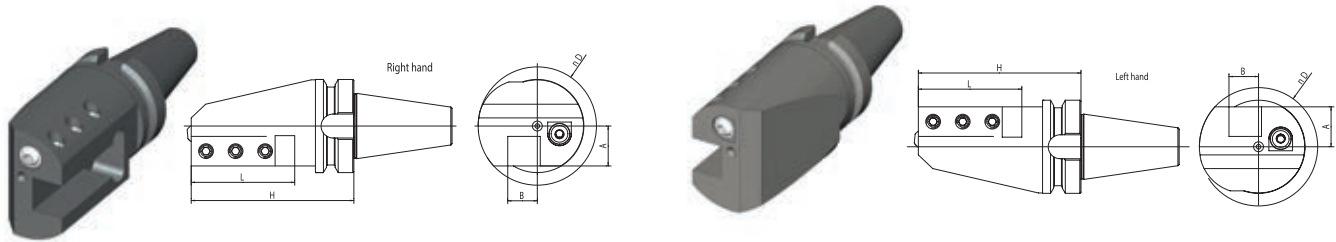

CODE N.	DESCRIPTION	ISO	B	H	L	A	D
152-11512	BT50H140-2525R	50	25	140	90	50	120
152-21504	BT50H140-2525L	50	25	140	90	50	120

DOUBLE CONTACT TRIPLE SQUARE TOOLHOLDER

DOPPELKONTAKT DREIFACH-VIERKANTWERKZEUGHALTER
PORTABARRA PARA CUADRADILLO DE DOBLE CONTACTO
ОПРАВКА ДК С ТРОЙНЫМ КВАДРАТОМ

PORTABARENO TRIPLO DOPPIO CONTATTO
PORTE OUTIL CARRÉ À DOUBLE CONTACT TRIPLE
双触面三方刀柄

MAS 403/BT

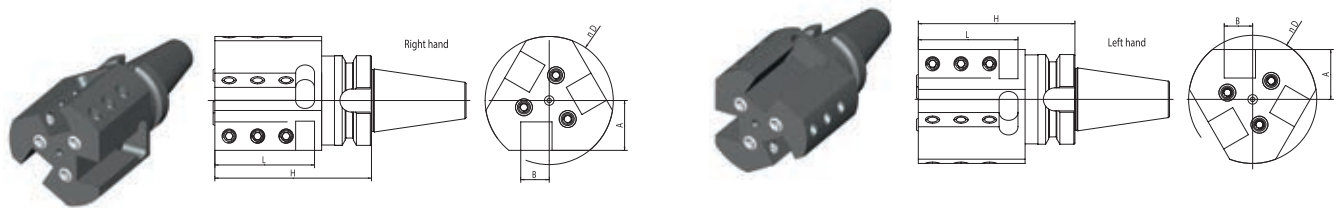

Code N.	DESCRIPTION	ISO	B	H	L	A	D
152-11514	BT50H140-3X2525R	50	25	140	90	50	120
152-21506	BT50H140-3X2525L	50	25	140	90	50	120

DOUBLE CONTACT BORING BAR HOLDER

DOPPELKONTAKT BOHRSTANGENHALTER
PORTABARRA PARA CUADRADILLO DE DOBLE CONTACTO
ОПРАВКА ДК ДЛЯ РАСТОЧНЫХ РЕЗЦОВ

PORTABARENO DOPPIO CONTATTO
PORTE OUTIL POUR BARRES D'ALESTAGES À DOUBLE CONTACT
双触面镗刀柄

MAS 403/BT

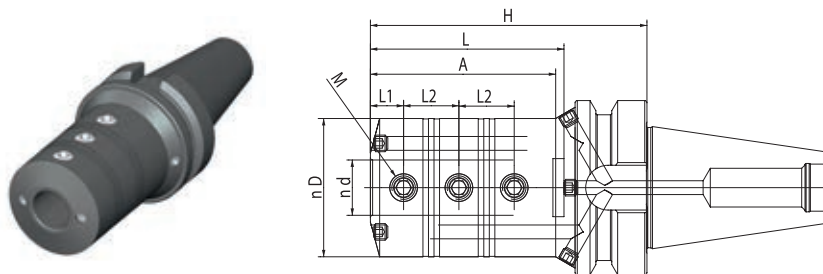

CODE N.	DESCRIPTION	ISO	d	D	H	L1	L2	L	A	M	PlugA	PlugB
155-21527	BT50H120D25BSL	50	25	55	120	14	23	74	70	M12x1,5	M8x8	M6x5
155-21528	BT50H125D32BSL	50	32	64	125	16	26	83	80	M12x1,5	M8x8	M6x5

ASSEMBLY SUPPORTS

MONTAGEBLOCK SUPPORTO DI MONTAGGIO
 SOPORTE DE MONTAJE SUPPORTS D'ASSEMBLAGE
 СТОЙКА ДЛЯ СБОРКИ ИНСТРУМЕНТА 支撑组件

It is very useful for all assembly and disassembly operations of the tools on the toolholders, either in horizontal or in vertical position. This process is carried out without any risk to damage casually the tool or the toolholder. It is a very simple system suitable for monolithic toolholders.

Consente di effettuare tutte le operazioni di montaggio e smontaggio degli utensili sui mandrini, sia in orizzontale che in verticale. Questi procedimenti avvengono con razionalità, sicurezza, rapidità e senza alcun rischio di danneggiare il mandrino o l'utensile. È il sistema che offre la massima semplicità d'uso per i mandrini monolitici.

Permite efectuar todas las operaciones de montaje y desmontaje de las herramientas sobre los conos, tanto en horizontal como en vertical. Esos procedimientos se realizan con seguridad, rapidez y sin algún riesgo de dañar el cono o la herramienta. Es un sistema que ofrece la máxima simplicidad de uso para los conos.

Dieses unkompliziertes System erlaubt die schnelle und sichere Montage und Demontage von Steilkegelaufnahmen in horizontaler und vertikaler Lage. Das Risiko der Werkzeugbeschädigung ist ausgeschlossen. Dieses einfache und sichere System eignet sich für alle Steilkegelaufnahmen.

Il permetts d'effectuer toutes les opérations de montage / assemblage / démontage des outils sur les mandrins. Ces proces se déroulent avec rationalité, sureté, vitesse et sans aucun risque d'endommagement accidentel du mandrin ou de l'outil. C'est un système qui offre la plus haute simplicité d'usage et il est bien indiqué pour les mandrin monolitiques.

Приспособление очень удобно для операций сборки и демонтажа инструмента, как в вертикальном, так и в горизонтальном положении. Оно позволяет избежать повреждения оправок или режущего инструмента. Это простое приспособление подходит для монолитных оправок.

它对于所有将工具以垂直或水平方向安装在刀柄上和从刀柄上拆除, 均非常有用。这一过程的执行不会对工具或刀柄产生任何破坏的风险。这一非常简单的系统适用于整体式刀柄。



CODE N.	ISO	ATTACK
237-33320	40	DIN 69871-DOUBLE CONTACT
237-33520	50	DIN 69871-DOUBLE CONTACT
237-33120	30	MAS 403/BT-DOUBLE CONTACT
237-33330	40	MAS 403/BT-DOUBLE CONTACT
237-33530	50	MAS 403/BT-DOUBLE CONTACT

03



BLANK TOOLHOLDER WITH SOFT SHANK

ROHLINGE MIT WEICHEM SCHAFT MANDRINI SEMILAVORATI A STELO TENERO
 CONOS SEMIACABADOS BARRES D'ALESAGE SEMI-FINIES
 ЗАГОТОВКИ ДЛЯ ОПРАВОК НЕЗАКАЛЕННЫЕ 带软柄的切断刀柄

MAS BT

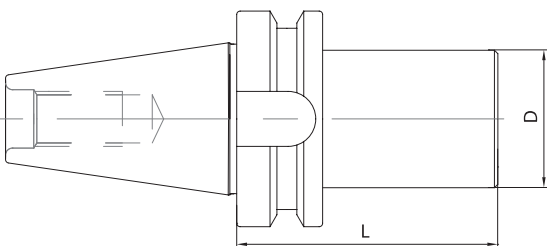

HRC26-28



CODE N.	DESCRIPTION	ISO	D	L
217-47202	BT40H160D63.5SM	40	63.5	160

CONTROL PINS

PRÜFDORNE BARRE DI CONTROLLO
 BARRAS DE CONTROL BARRES DE CONTROLLE
 КОНТРОЛЬНЫЕ ЦИЛИНДРЫ 测试棒

DIN 69871 A - MAS 403BT

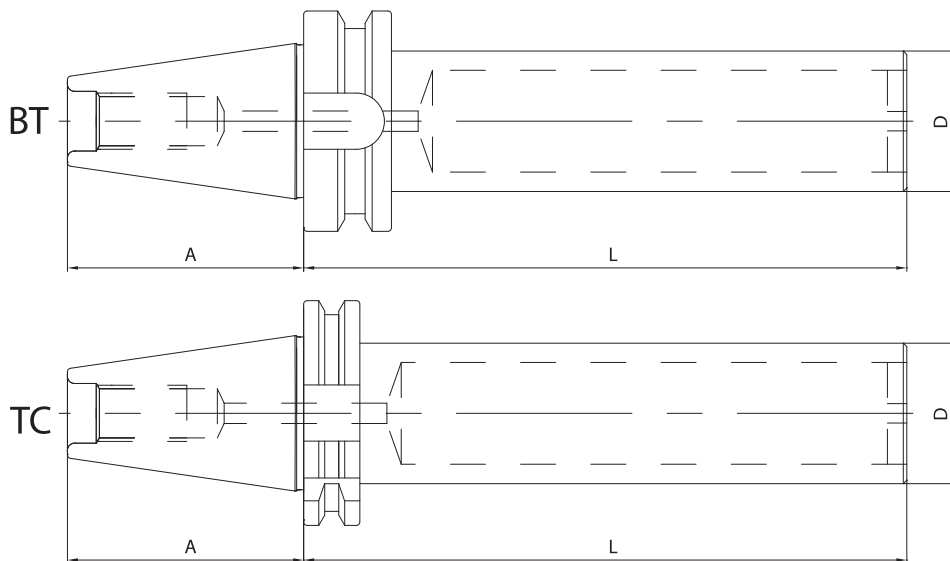

CODE N.	DESCRIPTION	ISO	D	L	A
217-77204	BT40H300D40BCDK	40	40	300	66,4
217-77205	BT50H350D50BCDK	50	50	350	103,3
217-77101	TC40H300D40BCDK	40	40	300	69,4
217-77102	TC50H350D50BCDK	50	50	350	103,25



SUPPLIED IN ALUMINIUM SUITCASE AND WITH TEST CERTIFICATE.
 FORNITE IN VALIGETTA IN ALLUMINIO E CON CERTIFICATO DI COLLAUDO.
 IM ALUMINIUMKOFFER UND MIT MESSPROTOKOLL GELIEFERT.
 SE SUMINISTRAN EN UN MALETIN DE ALUMINIO Y CON EL CERTIFICADO DE ENSAYO
 FOURNIES DANS UNE MALLETTTE EN ALUMINIUM ET AVEC CERTIFICAT DE CONTRÔLE.
 ПОСТАВЛЯЮТСЯ В АЛЮМИНИЕВОМ ЯЩИКЕ С СЕРТИФИКАТОМ СООТВЕТСТВИЯ.
 提供铝盒包装和检验报告



MAIN PRODUCTION PLANT - KINTEK TOOLING KFT - BEKESCSABA - HUNGARY

KINTEK

Toolholding Solutions Toolholding Solutions

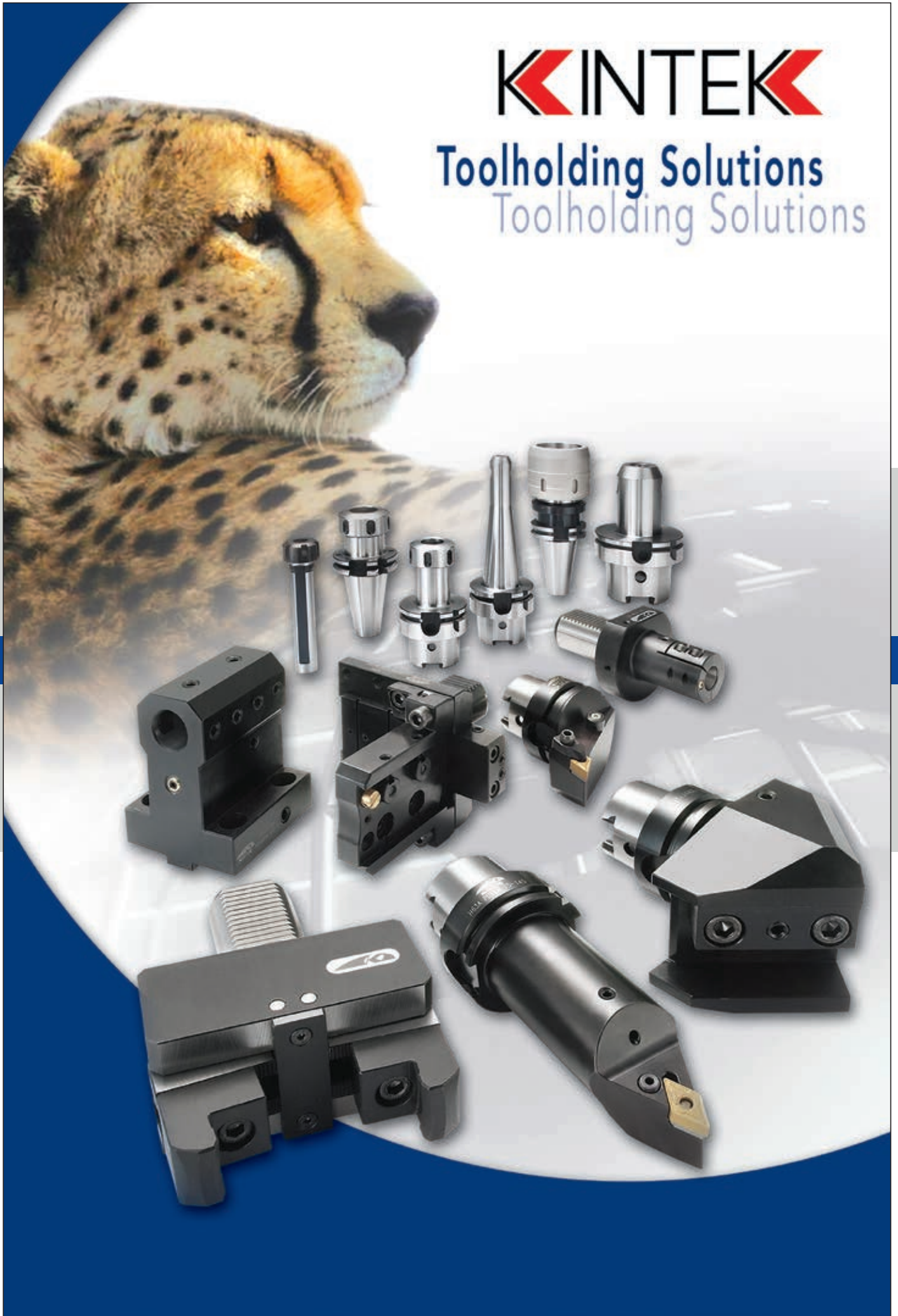

03

KINTEK